

# **Algae as a Biodiesel Feedstock: A Feasibility Assessment**

**DRAFT**

Submitted by:  
Center for Microfibrous Materials Manufacturing (CM<sup>3</sup>)  
Department of Chemical Engineering  
Auburn University, Alabama 36849-5127  
334-844-2023 (phone)  
334-844-2065 (fax)

Ron Putt  
Principal Investigator  
[ronputt@auburn.edu](mailto:ronputt@auburn.edu)  
334-221-6660 (cell)

November 20, 2007

**Table of Contents:**

• Executive Summary _____	1
• Introduction _____	3
• Overview of this Report _____	4
• Nutrients _____	5
• Animal Husbandry Summary _____	7
• Algae Growth Kinetics _____	7
• Overall System Design _____	9
• Digester _____	10
• Pond _____	10
• Carbonation _____	12
• Harvesting _____	12
• Experimental Program _____	14
• Economic Analysis _____	16
• The Next Step _____	20
• References _____	21

**Appendices:**

A. Air-to-Pond Carbon Dioxide Transport _____	22
B. Means of Enhancing Air-to-Water Carbon Dioxide Transport _____	24
C. Carbon Dioxide Stripping from Diesel Exhaust Gasses _____	28
D. Pond Mass Balance _____	33
E. Paddlewheel Power _____	34
F. Digester for Animal Litter _____	36
G. Harvesting _____	39
H. Dewatering and Drying _____	41
I. Energy Balance _____	43

## **Executive Summary**

Alabama has an immediate opportunity to lead the nation in becoming self sufficient with respect to liquid fuels for transportation. Mass cultivation of micro-algae in the state, using less than 3% of our land area, could produce the 3 B gallons of fuel we need every year. Through careful design and efficient operation of algae farms, the payback on the initial investment would be within a few years, which makes algaculture an attractive investment opportunity on its own. Factoring in the geo-political benefits of energy self-sufficiency and closing the loop on the carbon cycle makes the proposition of statewide algaculture compelling. With the potential for production rates exceeding 4,000 gallons of biodiesel per acre annually, algae-to-biodiesel is unique among the alternative fuels concepts in having the potential to be a 100% solution for our transportation fuel needs.

The seminal work on algae-to-biodiesel within the U.S. was the U.S Department of Energy Aquatic Species Program performed by the National Renewable Energy Laboratory (NREL) from the mid 1970's through the mid 1990's in response to the nation's first energy crisis. The original goal of the ASP was carbon dioxide mitigation, but early on they realized the biodiesel feedstock potential of micro-algae, and therefore redirected the program. Two key technology development needs were identified during the ASP, namely the cost and energy efficient means of (1) providing sufficient carbon dioxide to the ponds to support the high growth rates inherent to micro-algae, and (2) harvesting dilute (200-300 ppm) micro-algae from the pond water. The program was shut down by DOE in the mid-90's when gasoline returned to \$1 per gallon.

The present assessment, performed under contracts to the Choctawhatchee, Pea, and Yellow Rivers Watershed Management Authority and the Alabama Departments of Economic and Community Affairs and Agriculture and Industry, with cost sharing by the Alternative Energy Committee of Auburn University, was for technical and economic feasibility of statewide algaculture in Alabama for the production of biodiesel feedstocks from algal oil, and nutritional and animal feedstocks from algae meal. It consisted of experimental investigations, technology development, interviews with government agencies and private enterprises, and an engineering design and cost analysis. The assessment, as discussed herein, developed solutions for the challenges of providing sufficient carbon dioxide to the ponds and harvesting micro-algae using commercially available technology.

There were several important innovations during the course of the program, namely (1) integration of animal litter digesters to provide nutrients and energy for the algae farms, (2) integration of carbonation pits and their pumps with a novel linear pond design, (3) a low-cost harvesting system, and (4) a scheme for integration of algaculture with catfish aquaculture to improve the competitiveness of this industry within the state.

The economic analysis estimated an installed cost for 100 acre algae farms of less than \$1 million, and annual nets of \$200,000. The analysis identified key cost and price variables which are likely to have the biggest impact on the economic performance of the algae

farms, including those for petroleum crude, algal oil and meal, carbon from carbon dioxide capture, and commercial fertilizer.

The assessment resolved three phases to algaculture within Alabama, two near term and another somewhat longer term. The near term phases employ animal litter as the nutrient source for the algae ponds.

One phase would involve digesting poultry litter and cattle manure in an anaerobic digester which would produce methane, and carbon dioxide, to power a diesel generator that would provide electrical and thermal power to run the farm. The exhaust of the diesel generator would provide the heat for a drum dryer at the end of the algae harvesting system, and the cooled, carbon-dioxide rich exhaust would then feed the algae pond water via gas-liquid exchange in a carbonation pit. All the poultry litter and cattle manure in Alabama would provide about 2% of the nutrients for the state's liquid transportation fuels via algae-to-biodiesel.

The other near-term phase would integrate algae ponds with catfish ponds. Using algae ponds to remove catfish litter from the catfish ponds at an accelerated rate would improve the yields of the catfish ponds dramatically. The algae ponds would also hyper-oxygenate the catfish pond water and reduce, or eliminate, unwanted algae blooms in the catfish ponds. Productivity from the catfish ponds could easily triple, and the revenues from the algae ponds would match those of the catfish ponds. While the production of algae from the catfish farms would be only a small fraction of that from the poultry and cattle farms, it could have a significant beneficial impact on cost and quality for Alabama's catfish industry.

The longer term phase of algae farming would require capturing carbon dioxide from fixed and vehicle point sources in the state. An international movement is underway to scrub carbon dioxide from stack gases and then compress it for underground storage. A better solution would be to feed them to algae ponds. The carbon dioxide from Alabama Power's fossil-fuel fired power plants would provide 50% of the state's transportation fuels via algae-to-biodiesel. And a Welsh company, Maes Anturio Ltd, has a "greenbox" technology that can capture up to 90% of the carbon dioxide produced by vehicle engines; their original purpose in developing this technology was to feed algae farms. While these means of providing carbon dioxide are several years away, it would likely take the intervening years to perfect and implement algaculture on animal litter.

A credible scenario therefore exists in which algaculture can provide all the liquid fuels required for transportation within the state of Alabama. This scenario is financially attractive on its own, and the added benefits of sustainable energy self-sufficiency and closing the loop on the carbon cycle compel us to give it serious consideration.

## **Introduction**

Widespread cultivation of micro-algae has the potential to make Alabama, and the United States, self-sufficient in liquid fuels for transportation. Alabama could produce its 3 B gallons per year of transportation fuels from 1 million acres of algae ponds, which are only 3% of our land. This amount of acreage is not unreasonable to consider, since the state currently has more than 150,000 acres of man-made ponds, including recreational, farm, and aquaculture ponds.

Fuels from algal oil could either be biodiesel, which is a methyl ester produced via a straightforward reaction between most any vegetable oil and methanol, or straight (so called “green”) diesel, which is essentially the same as petro-diesel. Microalgae, as plants, store energy as carbohydrates and lipids, and these lipids are similar to those produced by row crops such as soy. Algae lipids can be extracted via processes similar to those used for soy, and sold to Alabama’s biodiesel producers, who are currently lipid-feedstock-limited. The meal remaining after extraction is rich (about 50%) in protein, and can therefore be used as a high-value ingredient in animal feeds.

The seminal work on algae-to-biodiesel was performed in the wake of our nation’s first energy crisis (mid 70’s to mid 90’s) by the U.S. Department of Energy’s National Renewable Energy Laboratory (NREL) in Golden, Colorado, whose original mission for the algae project was carbon dioxide mitigation (Sheehan 1998). During the early years of their program they discovered that some of the algae species were capable of producing 50% or more of their weight in lipids, under the proper growth conditions, and the program therefore transitioned to algae-to-biodiesel. The program included laboratory and field work to identify the most promising species and to optimize growth conditions for maximizing lipid yield per acre. Their key findings were that (1) high-rate open ponds, capable of producing 30 grams of algae per square meter per day, at 30% lipids content (yielding 4,000 gallons of biodiesel fuel per acre annually), would be the only capital-cost effective approach (as compared with a variety of enclosed photobioreactors) for producing lipids for transportation fuels, (2) native species of algae should be used, since they would take over the ponds anyway, and (3) the price of biodiesel produced from algal lipids would be in the \$2-4 per gallon range. The program was shut down in the mid-90’s when gasoline returned to a dollar per gallon.

After a careful study of their report, we additionally concluded that (1) the southeastern region of the U.S. is the best location for widespread algaculture owing to our abundance of pond-capable land, fresh water, sunshine, and animal husbandry, (2) algaculture needs to be intimately coordinated with animal husbandry, owing to the complementary natures of the plant and animal kingdoms with respect to nutrient needs and waste products, and (3) significant engineering would be required in the areas of nutrient feeds (notably carbon, nitrogen, and phosphorus) to the ponds, pond design, and the harvesting process.

Now that gasoline has reached \$3 per gallon, and with the ongoing political and military upheaval in the Mideast, we as a nation recognize the urgent need to identify and develop alternative fuels for transportation. Alabama’s Departments of Economic and Community Affairs, and Agriculture and Industry, along with the Choctawhatchee, Pea, and Yellow

Rivers Watershed Management Authority, have therefore commissioned Auburn University to perform a technical and economic assessment of algaculture for biodiesel production in our state, with Auburn University's Alternative Energy Committee as a cost sharing partner. The results of the assessment, contained in this report, are to serve as input to the decision-making process by the state and private industry as to what further steps should be taken toward commercialization of algaculture here.

### **Overview of This Report**

This report, as a reflection of the assessment itself, is organized based on the nutrient needs, specifically carbon dioxide, of microalgae for growth at economically practical rates (> 20 grams per square meter per day averaged throughout a 300 day growing season). We have learned during the assessment that atmospheric carbon dioxide, despite concerns about its increased concentration during the past two hundred years and the subsequent contribution to the so-called "greenhouse effect", is far too dilute (350-500 ppm by volume) to support this minimum economically viable growth rate.

Open ponds, even with paddlewheel mixers, would only absorb 1% of the daily carbon dioxide required. Efforts to improve the air-to-pond transport of carbon dioxide to meet the required growth rates, such as bubble column or wetted film contactors, would require more energy input than that produced by the ponds, and they would be prohibitively costly. This is why, in all the prior and current work on algae-to-biodiesel of which we are aware, concentrated (10% or more) carbon dioxide is supplied to the pond water. The NREL work focused on fossil-fuel power plant stack gases; other point-source carbon dioxide emitters include cement and lime plants, pulp and paper plants, breweries and other fermentation processes, and animal waste digesters.

Discussions with electric utility companies, cement plants, and pulp and paper mills conducted during the assessment revealed that, at least today, capturing the carbon dioxide emissions from the stacks would be complicated and expensive. Further, insufficient available land exists adjacent to these plants for growing the algae required to consume even a significant fraction of the carbon dioxide emitted. This is unfortunate, since Alabama Power exhausts enough carbon dioxide to support half of the state's liquid transportation fuel needs, via algae-to-biodiesel.

We therefore turned to the state's animal husbandry industry for carbon sources. The poultry litter from Alabama's chicken houses is currently sold as a fertilizer for land application; the manure from our dairy and beef cattle is generally left in the field to decompose. Land application of poultry litter is becoming an environmental concern, owing to phosphate buildup and runoff which result in unwanted algae blooms in our waterways.

One option for beneficial use of animal litter would be to feed it to anaerobic digesters located at algae farms. Digesters would convert the volatile organic compounds in them to methane and carbon dioxide, the former of which could be used to generate electrical and thermal energy for the farm. The carbon dioxide from the engine generator exhaust would be scrubbed by the pond water. Nitrogen, phosphorus, and trace metal nutrients

from the litter which leach into the digester water would be sent there as well. The mass balances show that the nutrient content in the animal litter is generally what the algae need for healthy growth.

The assessment examined animal litter as the first source of carbon for the ponds, via anaerobic digesters which would produce methane for the algae farms as well as carbon and other nutrients for the algae. The farm is thus designed based on the integration of an anaerobic digester and high rate algae growth ponds. This design also includes the harvesting system, which saw significant experimental development during the assessment. The challenge in harvesting is to remove suspended microalgae whose pond concentration is about 200 ppm (5,000 grams of water per gram of algae) via dewatering and drying operations which yield a product that is more than 90% dry solids, while staying within very tight cost and energy constraints.

Poultry litter and cow manure would provide at most 2.5% of the annual carbon required for our transportation needs. Although full implementation of algaculture supplied by digesters would take several years to implement and would serve as the first commercial opportunity for algaculture, we must find a much larger source of carbon if our goal is to supply all of our transportation needs via algae-to-biodiesel.

For this we turn to recent developments in the field of carbon dioxide capture, both at the power plant and vehicle level. There are programs internationally to capture and sequester carbon dioxide emissions from stationary point sources, particularly power plants, and vehicles. The former (see, for example, [www.co2captureproject.org](http://www.co2captureproject.org)) would compress the carbon dioxide and pump it into underground caverns. Instead, the carbon dioxide could be barged up or down river to algae farms. The latter is in demonstration by a Welsh company, Maes Anturio Ltd., whose end use for the carbon dioxide would be algae farms. Both of these opportunities are several years away from fruition and beyond the scope of the present study, which will therefore focus on present day sources of carbon dioxide and the other nutrients, namely animal litter.

## **Nutrients**

For the fast-growing algae species under consideration by this program, pond productivity during the growing season of February through November would be nutrient-limited. The rate of feeding nutrients to the pond is therefore of paramount importance in setting the overall direction of the algaculture program. This applies particularly to carbon. Supporting a growing season's average growth rate of 20 grams per square meter per day, with a range of perhaps 30 in the warmer months to 10 in the cooler, requires the addition of 10 grams of carbon per square meter per day on average, since algae are about 50% carbon. If the source of the carbon were atmospheric carbon dioxide alone, the rate of carbon dioxide uptake from the atmosphere by the pond would have to be 40 grams per square meter per day average, since carbon dioxide is about 25% carbon. Unfortunately the uptake of ponds by atmospheric carbon dioxide is 1% of that required (Appendix A).

We considered means of increasing the rate of carbon dioxide uptake (Appendix B), including sparging air bubbles up through a vertical tank, through which the pond water would be circulated, and by creating a thin wetted film atop a ramp elevated above the pond surface, along the top edge of which the pond water would be pumped. Unfortunately, within the limits of reasonable energy budgets and equipment sizes for these means of air-pond water contacting, the rates of carbon dioxide uptake by the pond water are still far from adequate. The reasons for this are (1) the low (350 ppm (V)) concentration of carbon dioxide in the atmosphere, and therefore (2) the low (millimolar) solubility of atmospheric carbon dioxide in the pond water; supplemental sources of carbon are required.

Fortunately Alabama is an ideal state for providing these supplemental carbon sources through our animal husbandry, namely poultry and cattle. These sources also provide the other nutrients required by the algae, notably nitrogen and phosphorus. This should not surprise us, since the plant and animal kingdoms were designed to be completely complementary by their Creator.

Poultry: Alabama produces 1 B chickens per year statewide, which produce 2 B pounds of litter; this litter is sold as a fertilizer for row crops. Over the years the high phosphate levels in the litter have caused phosphate buildup in the fields, with subsequent runoff into streams, rivers, and Mobile Bay, where unwanted algae blooms occur. ADAI is therefore looking for other beneficial uses of the litter to avoid these blooms.

An excellent use would be for feeding algae ponds. The means of feeding the ponds would ideally be via animal litter digesters, where the volatile solids would be converted by anaerobic bacteria to methane and carbon dioxide. The methane would be combusted to produce electrical and thermal energy for the algae farm, and the exhaust scrubbed of its carbon dioxide by the pond water. Using digesters for the poultry litter would therefore make inorganic carbon available to the ponds, as well as all the other nutrients from the litter, while providing an important source of energy for the farms. The algae farms would be energy self-sufficient (Appendix I), since the 26 kW of methane produced by the digester, for each acre of algae pond fed, are well more than required.

If all the carbon content of the poultry litter produced by the state were turned into algae, 1.2 B kg of algae would be produced (at 30% carbon content of the litter and 50% carbon content of the algae), which would then yield 32 M gallons of biodiesel at 20% lipids content of the algae; this would require 23,000 acres of ponds at a pond productivity of 24,000 kg (53,000 pounds) of algae per acre.

Cattle: 700,000 beef cattle are produced annually in Alabama. For a market weight of 800 pounds and a manure production rate of 20 pounds per pound of animal per year, 6% of which is carbon (half of the 12% volatile solids), 1.3 B pounds of algae could be produced, which would yield 35 M gallons of biodiesel and which would require 25,000 acres of high rate growth ponds. As with poultry litter, the manure would be fed to a digester to extract the methane content.



Catfish: The catfish industry in Alabama provides a unique opportunity for algaculture. Alabama produces 100 M pounds of catfish annually, but competition from Latin America and Asia is rapidly driving down our market share (by 30% in the past three years) and pricing (catfish fell from 85 to 65 cents per pound this year within a six week period). We need a new competitive advantage in the face of these foreign imports.

Catfish yields are typically 7,500 pounds per acre, or less, annually from the ponds in Alabama. The limit to this productivity is the rate of removal of litter by natural processes in the ponds, and buildup of litter in the ponds frequently results in algae blooms and crashes, which affect negatively the taste and quality of the meat. AU Fisheries estimates that productivity could increase more than threefold if the litter were harvested, and a program is underway at Auburn University's Fisheries Department to develop a suitable means to do so, in which the litter would be pumped out of the ponds, flocculated, settled, dewatered, and dried to pellets for use as dry fertilizer.

An alternative would be to pump the litter-laden water from the catfish ponds to a high rate algae pond on the farm, where the algae, in combination with aerobic bacteria in the water, would metabolize the litter and oxygenate the water; dense algae cultures can produce up to four-fold supersaturation of oxygen in water, thereby obviating catfish pond aerators.

The clear, oxygenated water from the algae harvesting process would be returned to the catfish ponds. In this way catfish productivity could be increased dramatically and the likelihood of harmful algae blooms and crashes in the catfish ponds reduced or eliminated. One acre of algae ponds on a catfish farm would be able to process the litter from four acres of catfish ponds, at a catfish productivity of 20,000 pounds per acre annually. And the revenue generated per acre by the algae pond would be about the same as that for the catfish ponds.

While this is an interesting option to consider for our aquaculture industry, the quantity of algae produced would be small in comparison to that produced by poultry litter and cattle manure. We therefore will discuss it no further in the present analysis.

### **Animal Husbandry Summary**

If we were able to turn the carbon content of all the poultry litter and cattle manure produced in the state annually into algae, which are 50% by weight carbon and which would be at least 20% by weight lipids, 67 M gallons of biodiesel would be the result. These would provide 2.2% of the 3 B gallons of liquid fuels consumed by the state annually for transportation.

### **Algae Growth Kinetics**

Much of the research during the Aquatic Species Program at NREL was on algae growth kinetics, in their efforts to achieve the target production rate of 30 grams of algae per square meter of pond per day; their approach was biological in nature. They were occasionally able to achieve the target growth rate, but not consistently. Based on our analysis of carbon transport rates to the ponds, and the published specific growth rates for

various algae species, we believe that growth rate limitations are frequently those placed by nutrient uptake rate limitations of the ponds. This can be illustrated by example.

Chlorella are fast-growing, robust, green micro-algae which are native to Alabama.

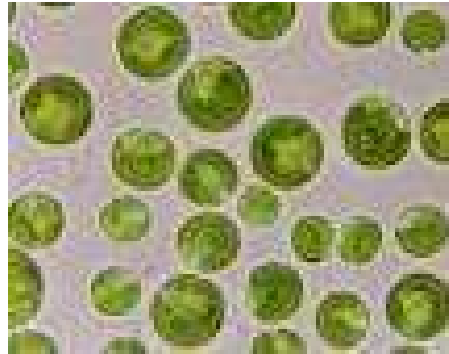

Because of their rapid growth rates they usually dominate open ponds here. Lipid contents in the 20-30 weight percent range have been reported for Chlorella, which, while below those of some other species (50-70 weight per cent lipids have been measured), are adequate; soy is typically 20% lipid.

Chlorella double in cell count every 8 hours or less if they have adequate nutrients and light, for pond temperatures in the range 20-35 °C. This corresponds to a specific growth rate constant  $u$  of 2.4 day<sup>-1</sup> in the expression

$$\frac{P}{D} = uC, \text{ where}$$

$P$  is the growth rate,  $\frac{\text{grams}}{\text{m}^2 \cdot \text{day}}$ ,

$D$  is the pond depth,

and  $C$  is the alga concentration,  $\frac{\text{grams}}{\text{m}^3}$  (or ppm).

For a specific growth rate constant of 2.4 day<sup>-1</sup> and our target pond concentration of 200  $\frac{\text{g}}{\text{m}^3}$ ,

$$\frac{P}{D} = 480 \frac{\text{g}}{\text{m}^3 \cdot \text{d}}.$$

For a pond depth of 0.2 meters, the areal productivity is then

$$\left( 480 \frac{\text{g}}{\text{m}^3 \cdot \text{d}} \right) (0.2\text{m}) = 96 \frac{\text{g}}{\text{m}^2 \cdot \text{d}},$$

which is nearly 5 times our target growth rate of 20 grams per square meter per day. Therefore, achieving acceptable growth rates, in our view, requires providing nutrients at a rate sufficient to maintain those growth rates.

### Overall System Design

An algae farm fed by animal litter would look something like the following:

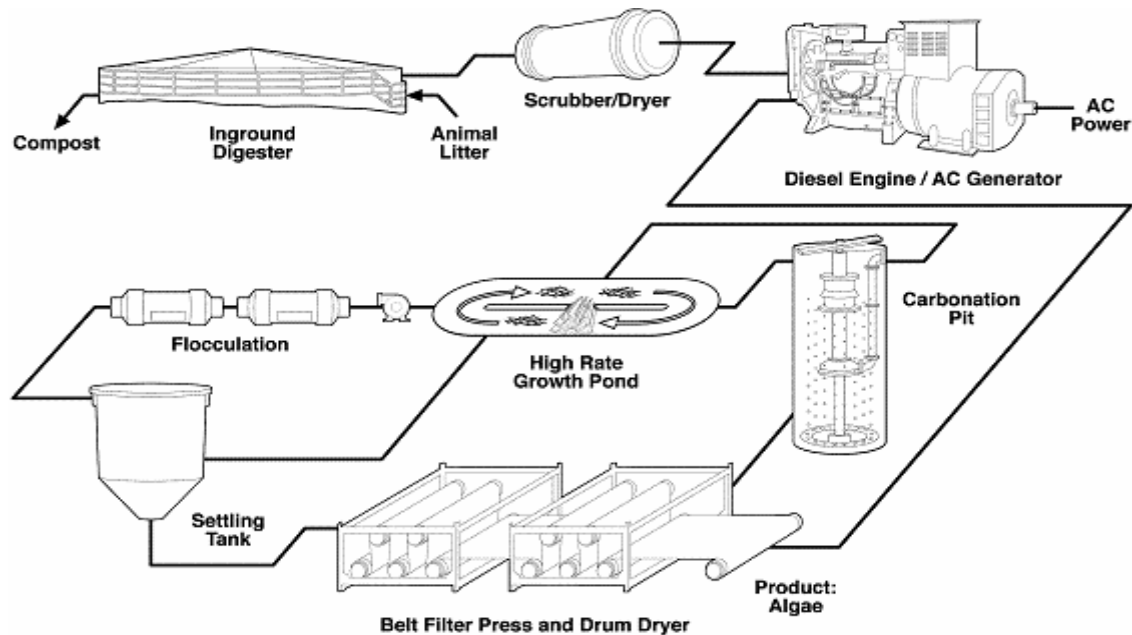

The digester would convert animal litter into methane and carbon dioxide gases which would flow to an engine/generator to produce electrical energy and an exhaust rich in carbon dioxide. The exhaust would provide heat for the drum dryer, and the high-rate algae growth ponds would be fed this cooled exhaust via carbonation pits, one for each pond, through which the pond water and diesel exhaust would flow countercurrently, so that up to 90% of the carbon dioxide would be absorbed by the pond water. Soluble nitrogen, phosphorus, and trace metal nutrients leached from the litter in the digester would flow to the ponds directly via makeup water pumped through the digester to the ponds.

The ponds would operate in a continuous, steady state mode. That is, the algae concentration, in the range 200-300 ppm, would remain essentially constant by the balancing of the harvesting rate with the photosynthetic growth rate. The pond water would flow continuously to a harvesting system, where the algae would be removed by flocculation and settling, and the clear, essentially algae-free water, would be returned to the pond.

The settled algae, 1-3% solids, would be pumped to a belt filter press for dewatering and subsequent drying over a series of drum dryers heated by the diesel exhaust. The dried algae would then be packaged for shipment to a processor who would extract the oil from the meal.

### Digester

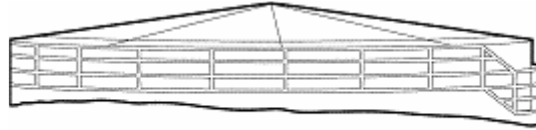

The digester, a pit in the ground with a fabric cover, would receive animal litter slurried with makeup water in a feed pit. Anaerobic bacteria would metabolize volatile organic compounds, producing methane and carbon dioxide which would be pumped through a scrubber and dryer on its way to the diesel generator. Stirring in the digester would be via a circulation pump, and un-digested solids would be continuously removed for sale as compost after dewatering and drying. The liquid flowrate through the digester would correspond to a residence time of at least 10 days.

### Pond

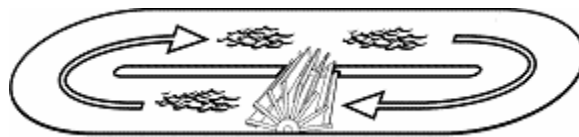

The baseline design is the standard high-rate growth pond, developed during the past 40 years, having an oval shape with a center wall and paddlewheel (Borowitzka 2005); area is one acre. This is typical of the ponds in the U.S. for growing Spirulina as a nutraceutical.



Economic analysis of a 100-acre farm (discussed later on in this report) revealed a strong incentive for increasing pond size to 10 acres. In doing this, the pond flowrate then matched the flowrate of the cantilever pump for the carbonation pit (see below), and we realized we could circulate the pond water with this pump, thereby eliminating the

paddlewheel at significant cost and energy savings. Further, we located the carbonation pit within, and at one end, of a linear pond, and coupled two ponds via their cantilever pumps. This eliminates the regions of slow and eddy flow which exist in the racetrack design, where poor mixing and algae settling would occur.

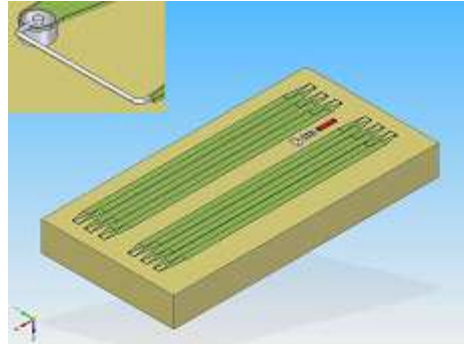

Circulation of the pond water would ensure that all the algae cells periodically make it to the photic zone for photosynthesis to occur. Circulation would also ensure good mixing of nutrients and prevent significant thermal gradients. A practical velocity for the water would be one half foot per second, which is a compromise between mixing effectiveness and mixing power; mixing power is related to the cube of velocity, such that velocities much higher would consume an excessive amount of energy as compared with the chemical energy content of the algae produced.

Key to the success of the algaculture program will be low cost and simplicity of the ponds and the associated processes, and so we have chosen unlined earthen ponds for the baseline design. Alabama is an excellent state for these ponds; there are presently 150,000 acres of such ponds in the state for recreation, farm use, and aquaculture. The center divider could be, as a minimum, a silt fence.

The design production rate of the algae in the pond is 20 grams per square meter per day as an annual average. The literature places an upper limit of 30-50 (Goldman 1995), and as the program matures we hope to get there, but for now we prefer a conservative number. We assume that the average is sustained during a 300 day growing season, with no production during the colder and darker months of December and January.

## Carbonation

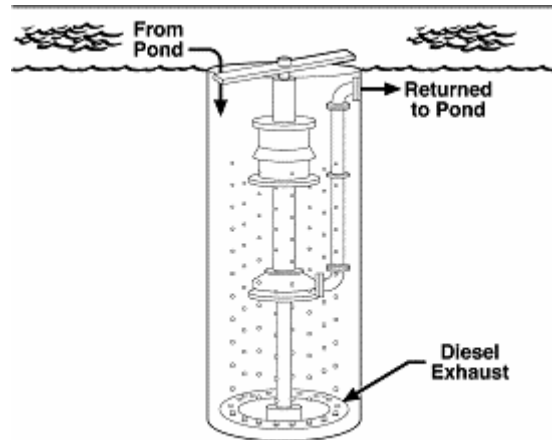

Air-to-pond carbon dioxide transfer would occur at 1% of the carbon dioxide uptake required to support the design growth rate of 20 grams per square meter per day, as shown in Appendix A. Artificial means of increasing this rate are impractical, as shown in Appendix B. We therefore require a concentrated (at least 10%) source of carbon dioxide to feed the ponds, and this would be done via an in-ground carbonation pit, discussed in Appendix C. Carbon-dioxide rich diesel exhaust would first be cooled through the drum or belt-oven dryer in the harvesting system, then sparged up through the carbonation pit, where it would exchange carbon dioxide with pond water flowing down into the pit. A cantilever pump would lift the carbon dioxide rich pond water from the bottom back to the pond. Given the high cost of the cantilever pumps, the farm would have one carbonation pit for every ten acres of ponds.

## Harvesting

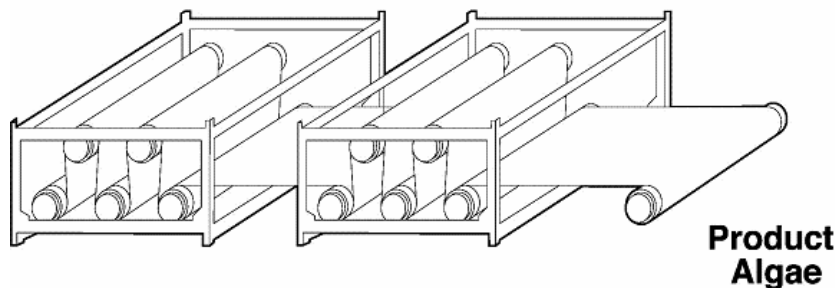
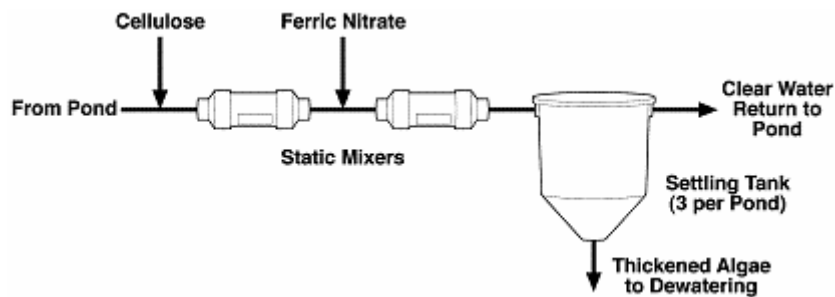

The small size of most microalgae (1-30 microns), particularly Chlorella (2-10 microns) is a significant advantage in high rate growth ponds because the algae are much easier to keep in suspension, so that they don't settle out on the bottom of the pond and therefore become lost in the process. This is particularly true if the residence time of the algae in the pond is no more than two or three days, since older micro-algae are prone to spontaneous flocculation into larger aggregates, which settle much more easily.

Their small size likewise makes harvesting them challenging. The concentration of algae in the growth ponds would be about 200 ppm, which means that for every gram of algae there would be 5,000 grams of water, and dewatering cannot be done simply by filtration; the filter media would blind almost immediately. Centrifugation would work, and it is done in preparing algae pastes for aquaculture. However the high initial and operating costs of centrifuges do not fit our low-cost model for algaculture in Alabama. Maturation, or settling, ponds could be used downstream of the growth ponds, which would allow the algae time to age and flocculate. The residence time in these ponds, however, would be measured in days, which would more than double the pond acreage of the farm. We consider this to be unacceptable from cost and land use considerations.

We have therefore developed, through laboratory experimentation, a low-cost, energy efficient, simple, and fully effective means of harvesting fresh microalgae from growth ponds. It comprises three steps, namely flocculation, dewatering, and drying. Flocculation is a two step process, in which cellulose fibers are first added, via a static mixer, followed by ferric nitrate, also via a static mixer. The cellulose, added at a rate of 10% of the algae weight, provides a fibrous structure on which the algae agglomerate upon addition of the ferric nitrate, yielding a robust, fibrous floc which stands up to the dewatering process.

The pond water containing the flocculated algae would be sent to one of three batch settling tanks, sized for a one hour residence time; one would be filling while the others are settling or draining. After each tank filled it would be allowed to settle for one hour, and then the floc at the bottom of the tank would be pumped to the belt filter press for dewatering. The press, which has the capacity for dewatering the algae from all the growth ponds on the farm, would increase the solids content from about 3% to 20% through mechanical action on the algae cake, to minimize the amount of thermal energy needed for drying. The clear water removed from the algae cake would be recycled to the ponds.

Drying the algae would be via a drum dryer; the dewatered algae would transfer to a drying belt and pass over a series of drums heated by air from a methane-fired forced air heater. The 26 kW (625 kWh/day), per acre, of thermal energy produced would be ample for drying the algae, since the latent heat required to increase solids content from 20% to 90% is 170 kWh/day per acre. It is likely that the product algae from the drum dryer would be in the form of a thin algae-paper, which could be wound up in rolls for storage and shipment, owing to the use of the cellulose flocculent.

## Experimental Program

The experimental phase of the feasibility assessment focused on the areas which we believe to be most important for the success of widespread algaculture in Alabama, namely algae growth rates and the harvesting process. These are discussed individually below.

**Algae Growth Rates:** We refurbished two concrete “A tanks” at the North Auburn Fisheries Unit, and fitted them with paddlewheel mixers and center walls.

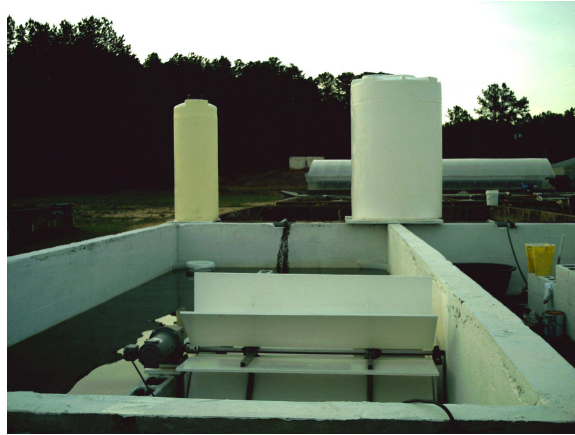

Each tank measures 9 feet x 25 feet, which is approximately 25 square meters, or 0.006 acres.

Prior to algae growth studies we developed a simple means of measuring the algae concentration in pond water using spectrophotometry. We developed a relationship between algae concentration and transmittance at 550 nm by a series of dilutions from a concentrated suspension; algae concentration was measured in the starting suspension by centrifugation, drying, and weighing the algae mass.

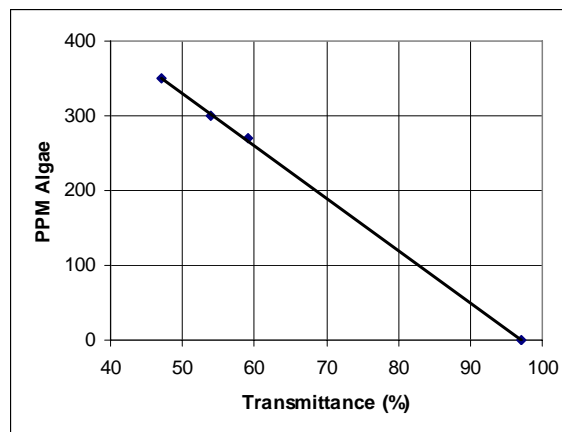

On 9 June, 2007, we filled one of the tanks with fresh water to which we added an inoculum of *Chlorella* which we had concentrated in a smaller pond. Nutrients were added by flushing a 5 gallon pail of poultry litter into the pond. In three days the



Chlorella concentration increased from 10 ppm to 130 ppm. Based on an exponential growth model,

$$\frac{dC}{dt} = uC, \text{ where } u \text{ is the growth rate constant,}$$

we calculated a growth rate constant of 0.84/day, which is much smaller than the literature value of 2.4/day, indicating nutrient limitations. However, even for this smaller growth rate constant, the production for a steady state concentration of 200 ppm would still be 34 grams per square meter per day, for a pond depth of 0.2 meters. These results reinforce our belief that we will be able to achieve our design seasonal average growth rate of 20 grams per square meter per day if we supply the ponds with sufficient nutrients.

We also measured pond temperature during the summer (July 21, 2007) to learn how warm it would get, since algae growth falls off at temperatures in excess of 95 F.

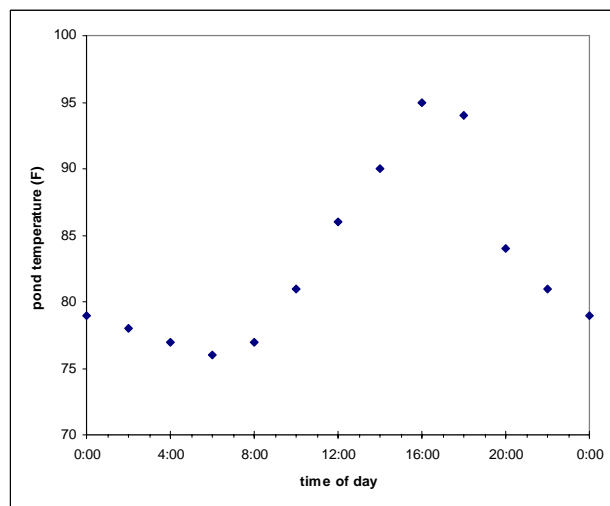

The data show that 95 F is reached briefly mid-afternoon, but otherwise the pond temperature in the summer would be acceptable for good algae growth.

Harvesting: The laboratory program developed a simple and cost effective means of harvesting algae from dilute (200 ppm) pond suspensions. The harvesting method which we developed begins with a two step flocculation process in which cellulose is first mechanically mixed with the pond water, followed by ferric nitrate addition via a static mixer. In production the cellulose, as a 5% water suspension, would also be added via a static mixer.



The flocculated algae are then allowed to concentrate via settling, and then dewatered via filtration.

We manually pressed the filtered algae to further dewater it; this would be done by a belt filter press in production. We dried the algae in an oven, and this would be done in production with a drum dryer downstream the belt filter press. The dried algae are fibrous in nature, owing to the use of cellulose flocculent, and would likely form a paper-like structure which could be wound as rolls for storage and shipment.

### **Economic Analysis**

Tables 1 and 2 provide a preliminary set of costs and revenues for 100 pond-acre algae farms with two different pond sizes, Table 1 for 100 one-acre ponds, Table 2 for 10 ten-acre ponds. A farm based on 1 acre ponds would be the lower technical risk option, because 1 acre ponds are in commercial use in the U.S. for growing *Spirulina*, a popular nutraceutical. However, it would also be the more expensive option, since there would be 100 each of most of the process equipment for the ponds, versus 10 each for the ten acre ponds, and since the cost for most process equipment is well less than linear with respect to size or capacity.

Each table has four sections, including front end fixed costs (nutrient input and power generation), back end fixed costs (dewatering and drying), pond fixed costs, and revenues and variable costs of operations. The front and back end systems service all of the ponds on the farm, therefore requiring only one of each line item for the farm. At this stage the costs and revenues are budget-level estimates, and can only be firmed up as part of a follow-on engineering study. We assume a selling price of 30 cents per pound for the lipid, since soy oil is currently selling for 37 cents, and we assume a selling price of 7 cents per pound for the algae meal, since corn is selling for \$4 per bushel (56 pounds). Total fixed costs for the ponds are less than half for the farm having 10 acre ponds as compared to those for the farm of 1 acre ponds, which would strongly encourage an aggressive effort to make the ponds as large as possible. Municipal wastewater treatment systems in California, which use high rate algae ponds as part of the treatment process, operate multi-acre ponds successfully up to 15 acres.

All the process equipment in these tables is commercially available today, with two exceptions, the cantilever pump and the drum dryer. The cantilever pumps for providing the high flowrate circulation between the ponds and the carbonation pits would require a custom design to match the specifications with the budgeted cost; currently available cantilever pumps are over-designed and overpriced for our application. Informal discussions with a cantilever pump manufacturer indicate that we should be able to meet our performance and cost goals. For the ten-acre pond design we would locate the carbonation pit in the pond, and use the cantilever pump for circulating the pond water as well, thereby eliminating the need for a paddlewheel mixer. This is another strong incentive for choosing the ten-acre pond size.

Table 2 indicates an initial investment of \$1 million per farm; revenues for each farm could exceed \$200,000 per year, depending on the market pricing of algae oil and meal, resulting in a payback period of a few years. Revenue per acre would be approximately \$2,000 per year, for the assumed pricing of 30 cents per pound for the lipid and 7 cents per pound for the meal; these prices are based on \$85 per barrel crude oil and \$4 per bushel corn. For a million-acre statewide program to supply 100% of Alabama's liquid transportation fuels via algae-to-biodiesel, an investment of \$10 billion would be required.

As a stand-alone investment the algae farms appear to be fairly attractive. The life of the farms would presumably be several decades, until the next transportation technology takes over, thus making for fairly large present-value calculations. Moreover, additional but difficult-to-value investment incentives would accrue, such as carbon credits, closing the loop on the carbon cycle, and some valuation on making Alabama completely self-sufficient with respect to liquid fuels for transportation.

TEA1	19-Nov	Base Case: 100 One-Acre Ponds						
<b>Front End</b>								<b>Cost</b>
Land								\$240,000
Equipment and Process Building, and Office								\$30,000
Digester Pit								\$6,600
Digester Cover								\$12,600
Grinder Pump								\$1,000
Compost Pump								\$1,000
Methane Blower								\$1,000
Litter Pit								\$1,000
Scrubber/Dryer								\$5,000
Engine/Generator								\$25,000
Exhaust Blower								\$1,000
<b>Back End</b>								
Belt Filter Press								\$40,000
Conveyor Oven								\$40,000
Water Return Pump								\$500
Overflow Tank								\$1,000
Subtotal								\$405,700
<b>Ponds</b>								
Pond								\$160,000
Paddlewheel								\$300,000
Carbonation Pit								\$50,000
Static Mixer								\$10,000
Static Mixer								\$10,000
Carbonation Water Pump								\$100,000
Harvesting Water Pump								\$30,000
Ferric Metering Pump								\$35,000
Cellulose Metering Pump								\$7,700
Settling Tank								\$50,000
Settling Tank								\$50,000
Settling Tank								\$50,000
Algae Pump								\$5,000
Subtotal								\$857,700
Equipment Total								\$1,263,400
Installation, Plumbing, Controls		10%	of Equipment Total					\$126,340
Installed Cost								\$1,389,740
<b>Algae Production</b>								
		<b>kg/d</b>	<b>lb/y</b>	<b>lb/y</b>				
Total		81	53,460	5,346,000				
Lipid		16.2	10,692	1,069,200	30 cents/lb			\$320,760
Meal		64.8	42,768	4,276,800	7 cents/lb			\$299,376
					total	gross		\$620,136
<b>Materials</b>								
litter		133	87,780	8,778,000	\$30/ton			\$131,670
ferric ion		10	6,600	660,000	2 cents/lb			\$13,200
cellulose		8	5,280	528,000	\$20/ton			\$5,280
water	10,000 gal	40,000						
O&M								\$50,000
						materials		\$200,150
<b>Labor</b>								
Foreman								\$60,000
Technicians								\$200,000
						labor		\$260,000
net								\$159,986

Table 1: Costs and Revenues Projected Based on 1 Acre Pond Size



#### Notes on Tables

Land: The total size of the farm is estimated to be 120 acres, and we assume a purchase price of \$2,000 per acre.

Building: We assume a 10,000 square foot steel building on a slab.

Digester Pit: The pit would hold 830,000 gallons, approximately 3,300 cubic meters, at a cost of \$2 per cubic meter.

Digester Cover: A digester of 3,300 cubic meters, if circular, would be 40 meters in diameter if it is 5 meters deep. The area of the cover would be approximately 1,260 square meters, and we estimated the cost at \$10 per square meter.

Grinder Pump: 60 gpm pump for sewage treatment.

Compost Pump: 40 gpm pump for sewage treatment.

Methane Blower: 200 cfm.

Litter Pit: The pit would hold 83,000 gallons, approximately 330 cubic meters, at a cost of \$2 per cubic meter, rounded up to \$1,000.

Scrubber/Dryer: 200 cfm, engineering estimate of cost in large-quantity purchase.

Engine/Generator: 100 kW at \$250 per kW.

Exhaust Blower: 2,000 cfm.

Belt Filter Press: 0.37 tons per hour of dry algae, which is well within the capacity of the smallest available press.

Conveyor Oven: Engineering estimate for 0.37 tons per hour gas-fired oven.

Water Return Pump: 160 gpm.

Overflow Tank: 1,000 gallons.

Pond: 80,000 cubic meters for 100 acres, at \$2 per cubic meter.

Paddlewheel: Engineering estimate of \$3,000 each for the one-acre pond paddlewheels. For the ten-acre ponds the carbonation pumps would circulate the water, and no paddlewheels are therefore required.

Carbonation Pit: The pits would be 25 feet in diameter and 10 feet deep, each sized for 10 acres of pond. For the one-acre ponds, one carbonation pit (and pump) would be shared by ten ponds, to keep the costs down. For the ten-acre ponds there would be a pit (and

pump) at one end of the pond. Each pit is estimated to be \$5,000, based on typical costs for excavation and concrete work.

**Static Mixers:** The harvesting system flow rate is 70 gpm per acre. There would be 100 pairs of static mixers (one each for the ferric nitrate and cellulose additions) for the one-acre pond farm, and 5 pairs for the ten-acre pond farms, since the ponds are operated as tandems.

**Carbonation Water Pump:** These would be 20,000 gpm cantilever pumps, ten per farm. A pump manufacturer estimated that, properly designed, these could be \$10,000 each in high quantity production.

**Harvesting Water Pump:** 70 gpm centrifugal pump for the one-acre ponds, 1,400 gpm for the ten-acre pond pairs.

**Ferric Metering Pump:** 0.25 gpm and 5 gpm gear pumps.

**Cellulose Metering Pump:** 0.03 and 0.6 gpm flexible impeller pumps.

**Settling Tanks:** 500 gallon and 10,000 gallon conical bottom polyethylene tanks.

**Algae Pump:** 1.5 gpm and 30 gpm diaphragm pumps.

### **The Next Step**

In the event that the state, industry, and investment community would like to pursue algaculture for biodiesel and animal feedstocks, the following next steps are suggested:

**Engineering Study:** A detailed engineering study should be conducted on the system and components to nail down performance and costs. While most of the equipment is commercially available, custom engineering would be required for the pond, the paddlewheel pond mixer (if needed), the cantilever pump for the carbonation pits, and the drum dryer heated by diesel exhaust.

**Enclosed Photobioreactor Assessment:** Several companies are developing enclosed systems as alternatives to open ponds. Their production and cost data should be verified and compared with those of open ponds.

**Pilot Project:** A one to ten acre pond should be built and integrated with a digester and harvesting system. The pilot farm should be operated at least two complete growing seasons to quantify productivity in Alabama.

**Product Evaluation:** The algae produced by the pilot farm should be processed to lipid and meal. The lipid should be sampled or sold to Alabama's biodiesel producers so that they can tune their processes accordingly. Feed studies should be performed on the meal to determine how best to use it in the animal feed industry. These studies would update

those performed during the past 40 years which generally reported good success with algae meal as a protein and nutrient source for animal feeds (Martin, 1971). Moreover, since Chlorella sells at retail today for \$25 per pound as a nutraceutical, it would be worthwhile to explore this market for the meal as well.

Re-assessment: A technical and economic re-assessment should be performed using data from the above activities, to serve as a basis for commercialization business plans.

These efforts could be accomplished in a period of less than three years, at an estimated cost of less than \$3 million.



## References

Anderson, R; Clean Tech, March, 2002.

Borowitzka, M; Algae Culturing Techniques, Elsevier, 2005.

Emmert, R; Chemical Engineering Progress, 50, # 2, p. 87-93, 1954.

Goldman, J; Water Research, 13, p. 119-136, 1979.

Martin, J; Southern Journal of Agricultural Economics, p. 137, 1971.

Quinn, J; Journal of Geophysical Research, 76, #6, p. 1539-1549, 1971.

Schindler, D; Journal of Phycology, 7, p. 321-329, 1979.

Shah, Y; AIChE Journal, 28, # 3, p. 353-379, 1982.

Sheehan, J; NREL/TP-580-24190, July, 1998.

Vinyard, S; Vinyard Technologies, private communication, 2007.

Wanninkhof, R; Journal of Geophysical Research, 97, C5, p. 7373-7382, 1992.

## Appendix A: Air-to-Pond Carbon Dioxide Transport

Overview:

This is an analysis of the transport rate of carbon dioxide from the atmosphere to the pond. It shows that the calculated, and measured, transport rate is about 1% of that required to support our design growth rate of 20 grams of algae per square meter per day.

Air-to-Pond Surface Mass Transport:

### 1. Carbon Dioxide Concentration in Air

Carbon Dioxide Content of Air: 385 ppm by volume

Ideal Gas Law:  $PV = nRT$

Number of Moles in 1 Cubic Meter of Air at 1 atm and 27 °C:

$$n = \frac{(1 \text{ atm})(1000 \text{ L})}{\left(0.082 \frac{\text{L atm}}{\text{mol K}}\right)(300 \text{ K})} = 41 \text{ mol Air}$$

Concentration of Carbon Dioxide:

$$C = \left(41 \frac{\text{mol Air}}{\text{m}^3}\right) \left(0.000385 \frac{\text{L CO}_2}{\text{L Air}}\right) = 0.016 \frac{\text{mol CO}_2}{\text{m}^3}$$
$$\text{or } \left(0.016 \frac{\text{mol CO}_2}{\text{m}^3}\right) \left(44 \frac{\text{g CO}_2}{\text{mol CO}_2}\right) = 0.7 \frac{\text{g CO}_2}{\text{m}^3}$$

### 2. Mass Transport Rate

Air to Pond Surface

Wanninkhof & McGillis (Wanninkhof 1992) show a plot of the gas phase mass transport rate,  $K$ , versus wind speed,  $U$ , which reaches an asymptote of 5 cm per hour as  $U$  approaches 0.

Assuming that, at best, the carbon dioxide concentration in the pond water is zero, the maximum gas phase carbon dioxide mass transport flux,  $N$ , is:

$$N = CK = \left(0.7 \frac{\text{g CO}_2}{\text{m}^3}\right) \left(5 \frac{\text{cm}}{\text{h}}\right) \left(\frac{1 \text{ m}}{100 \text{ cm}}\right) \left(\frac{24 \text{ h}}{1 \text{ d}}\right) = 0.84 \frac{\text{g CO}_2}{\text{m}^2 \text{ day}}$$

Algae Growth Rate Supported by This Flux:

$$P = \left(0.84 \frac{\text{g CO}_2}{\text{m}^2 \cdot \text{d}}\right) \left(\frac{1 \text{ g Carbon}}{4 \text{ g CO}_2}\right) \left(\frac{2 \text{ g Algae}}{1 \text{ g Carbon}}\right) = 0.42 \frac{\text{g Algae}}{\text{m}^2 \cdot \text{d}}$$

## Pond Water Surface-to-Bulk Mass Transport

Quinn & Otto (Quinn 1971):

$$N = \frac{D_{AB}C}{\delta}, \text{ where}$$

$N$  is the carbon dioxide flux,

$C$  is the carbon dioxide concentration at the surface,

and  $\delta$  is the film thickness for mass transport.

Using typical values for the diffusivity of carbon dioxide through water from Quinn & Otto of  $D_{AB} = 2 \cdot 10^{-5} \text{ cm}^2/\text{s}$  and  $\delta = 100 \text{ microns } (\mu\text{m})$ :

$$N = \frac{\left(2 \cdot 10^{-5} \frac{\text{cm}^2}{\text{s}}\right) \left(0.2 \frac{\text{g CO}_2}{\text{m}^3}\right)}{100 \mu\text{m}} \left(\frac{10^6 \mu\text{m}}{1 \text{ m}}\right) \left(\frac{1 \text{ m}^2}{10^4 \text{ cm}^2}\right) \left(\frac{3600 \text{ s}}{1 \text{ h}}\right) \left(\frac{24 \text{ h}}{1 \text{ d}}\right),$$
$$N = 0.35 \frac{\text{g CO}_2}{\text{m}^2 \text{ d}}.$$

Algae Growth Supported by This Flux:

$$P = \left(0.35 \frac{\text{g CO}_2}{\text{m}^2 \cdot \text{d}}\right) \left(\frac{1 \text{ g C}}{4 \text{ g CO}_2}\right) \left(\frac{2 \text{ g Algae}}{1 \text{ g C}}\right) = 0.18 \frac{\text{g Algae}}{\text{m}^2 \cdot \text{d}}$$

Discussion:

The above calculations indicate that the slower carbon dioxide transport process is on the water side of the air-water interface. Schindler (Schindler 1971) presents data taken from two different lakes which show carbon transport of about 0.2 g carbon per square meter per day, which would support an algae production rate of 0.4 g algae per square meter per day. This compares well with the air and liquid side calculations above, particularly given the four-fold range of liquid side film thicknesses presented by Quinn & Otto.

We can therefore assume that the maximum production rate of algae in the high-rate growth ponds, based on atmospheric carbon dioxide alone, is well less than 1 g algae per square meter per day, far short of the 20 g algae per square meter per day target. Therefore the major supply of carbon must come either from animal litter digesters, aerobic bacterial breakdown of organic carbon in aquaculture pond waters fed to the high rate ponds, or from mobile and stationary point source carbon dioxide emitters.

## Appendix B: Means of Enhancing Air to Water Carbon Dioxide Transport

### Overview

Appendix A showed that, under normal pond conditions, the transport of carbon dioxide from the air to the pond is 1% of that needed to sustain the design algae production rate of 20 g per square meter per day, owing to the low concentration of carbon dioxide in the air. We therefore explored two means of enhancing the transport rate, namely a bubble column and a wetted film ramp, both of which proved infeasible. These are discussed below.

### Bubble Column

A one acre pond would produce 80 kg of algae per day at a production rate of 20 g per square meter per day, and thus would require 40 kg of carbon. If all the carbon were to come from the atmosphere as carbon dioxide, 160 kg of carbon dioxide would have to be transported from the air to the pond.

The flow rate of air required for this is as follows:

$$Q = \left( 160 \frac{\text{kg CO}_2}{\text{d}} \right) \left( \frac{1 \text{ m}^3 \text{ air}}{0.7 \text{ g CO}_2} \right) \left( \frac{1000 \text{ g}}{1 \text{ kg}} \right) \left( \frac{1 \text{ d}}{24 \text{ h}} \right) \left( \frac{1 \text{ h}}{3600 \text{ s}} \right) = 2.6 \frac{\text{m}^3 \text{ air}}{\text{s}} .$$

According to Shah (Shah 1982), to maintain bubbly flow (small, distinct bubbles with minimal coalescence, and therefore high interfacial area for gas-liquid transport), the superficial gas phase velocity in the column should be less than 0.03 meters per second.

The minimum column area would then be

$$A = \left( 2.6 \frac{\text{m}^3 \text{ air}}{\text{s}} \right) \left( \frac{1 \text{ s}}{0.03 \text{ m}} \right) = 87 \text{ m}^2 ,$$

and the minimum column diameter would be

$$D = \sqrt{4 \left( \frac{87 \text{ m}^2}{\pi} \right)} = 11 \text{ m or } 35 \text{ ft} .$$

Such a large column would be well beyond the size and cost constraints for the one acre pond. Further, the compressor power for blowing 2.6 cubic meters of air per second (4800 cfm) against a minimum water column height of 2 meters would be about 10 kW, which is far in excess of the power budget for the one acre pond.

## Wetted Ramp Contactor

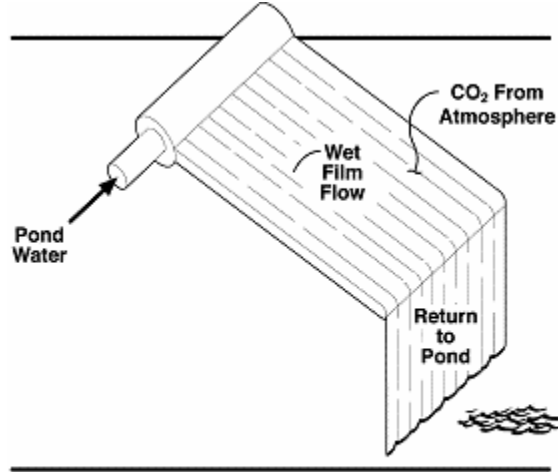

Another contacting option would be to provide a ramp above the pond, at the top of which a portion of the pond water would be pumped so as to provide a thin film of water flowing down the surface of the ramp, where the water would absorb atmospheric carbon dioxide at a higher rate than in the pond itself. We budgeted 1 kW of pumping power for this analysis.

The pumping power relationship is  $P = Q\rho gH$ . For a power of 1 kW and a ramp height at the high end of 6 feet (2 meters) the flow is as follows:

$$Q = \frac{P}{\rho g H} = \frac{1 \text{ kW}}{\left(1000 \frac{\text{kg}}{\text{m}^3}\right) \left(9.8 \frac{\text{m}}{\text{s}^2}\right) (2 \text{ m})} \left(\frac{1000 \text{ J}}{1 \text{ kJ}}\right) \left(\frac{3600 \text{ s}}{1 \text{ h}}\right) = 180 \frac{\text{m}^3}{\text{h}} = 0.05 \frac{\text{m}^3}{\text{s}}.$$

From *Perry's Chemical Engineers' Handbook* (see also Emmert 1954), the thickness of a falling film on an inclined ramp is as follows:

$$m = \sqrt[3]{\frac{3G\mu}{g\rho^2 \sin a}},$$

where  $G$  is the mass flow rate per unit width (22 meters, the width of the racetrack) of the ramp:

$$G = \frac{\left(0.05 \frac{\text{m}^3}{\text{s}}\right) \left(\frac{1000 \text{ kg}}{\text{m}^3}\right)}{22 \text{ m}} = 2.3 \frac{\text{kg}}{\text{m} \cdot \text{s}},$$

$$\mu = \text{pond water viscosity} = 0.01 \frac{\text{g}}{\text{cm} \cdot \text{s}} = 0.001 \frac{\text{kg}}{\text{m} \cdot \text{s}},$$

$$g = 9.8 \frac{\text{m}}{\text{s}^2},$$

$$\rho = \text{pond water density} = 1000 \frac{\text{kg}}{\text{m}^3},$$

$$a = \text{ramp angle with horizontal, here } 60 \text{ degrees; } \sin(60^\circ) = 0.9,$$

$$\text{and } m = \sqrt[3]{\frac{3 \left( 2.3 \frac{\text{kg}}{\text{m} \cdot \text{s}} \right) \left( 0.001 \frac{\text{kg}}{\text{m} \cdot \text{s}} \right)}{\left( 9.8 \frac{\text{m}}{\text{s}^2} \right) \left( 1000 \frac{\text{kg}}{\text{m}^3} \right) (0.9)}} = 0.0009 \text{ m} = 0.9 \text{ mm}.$$

The average film velocity is the flow rate divided by the cross-sectional area of the film:

$$v = \frac{0.05 \frac{\text{m}^3}{\text{s}}}{(22 \text{ m})(0.0009 \text{ m})} = 2.5 \frac{\text{m}}{\text{s}}.$$

The dimensionless parameter  $\frac{m^2}{D_{AB}\tau}$  in *Perry's* is as follows:

$$m = \text{film thickness} = 0.09 \text{ cm},$$

$$D_{AB} = \text{diffusivity of carbon dioxide through water} = 2 \cdot 10^{-5} \frac{\text{cm}^2}{\text{s}},$$

$$\tau = \text{transit time of film on ramp} = \frac{2 \text{ m}}{(\sin \theta) \left( 2 \frac{\text{m}}{\text{s}} \right)} = 0.9 \text{ s},$$

$$\text{and } \frac{(0.09 \text{ cm})^2}{\left( 2 \cdot 10^{-5} \frac{\text{cm}^2}{\text{s}} \right) (0.9 \text{ s})} = 450.$$

The Reynolds Number is as follows:

$$\text{Re} = \frac{4G}{\mu} = \frac{4 \left( 2.3 \frac{\text{kg}}{\text{m} \cdot \text{s}} \right)}{0.001 \frac{\text{kg}}{\text{m} \cdot \text{s}}} = 9200.$$

For  $\text{Re} > 1000$ ,  $H_L = 3 \text{ meters} = \frac{G}{\rho k_L}$ , where  $k_L$  is the liquid phase mass transfer coefficient.

$$k_L = \frac{2.3 \frac{\text{kg}}{\text{m} \cdot \text{s}}}{\left(1000 \frac{\text{kg}}{\text{m}^3}\right) (3 \text{ m})} = 0.0008 \frac{\text{m}}{\text{s}}$$

The carbon dioxide transport rate from air to water on the ramp is then

$$NA = k_L (C - 0) A,$$

where  $C$  is the concentration of carbon dioxide on the water surface, assumed to be the equilibrium concentration, and in this analysis we assume that the bulk concentration of carbon dioxide is zero.

$$\left(0.0008 \frac{\text{m}}{\text{s}}\right) \left(0.2 \frac{\text{g CO}_2}{\text{m}^3}\right) (22 \text{ m}) (3 \text{ m}) = 0.01 \frac{\text{g CO}_2}{\text{s}}$$

This would support a pond growth rate of

$$\left(0.01 \frac{\text{g CO}_2}{\text{s}}\right) \left(\frac{3600 \text{ s}}{1 \text{ h}}\right) \left(\frac{24 \text{ h}}{1 \text{ d}}\right) \left(\frac{2 \text{ g Algae}}{4 \text{ g CO}_2}\right) = 432 \frac{\text{g Algae}}{\text{d}} \text{ for a one acre pond.}$$

However, the daily production of a 1 acre pond, by design, is 80 kg. The ramp would therefore provide only 0.5% of the daily production requirement of carbon dioxide. Nonetheless, it is instructive to calculate the enhancement of carbon dioxide uptake by a wetted ramp as compared with the pond itself.

On the ramp, the algae growth rate supported by carbon dioxide transport would be:

$$P = \frac{432 \frac{\text{g Algae}}{\text{d}}}{(22 \text{ m}) (3 \text{ m})} = 6.5 \frac{\text{g Algae}}{\text{m}^2 \cdot \text{d}}.$$

This compares well with that of the pond itself,  $0.18 \frac{\text{g Algae}}{\text{m}^2 \cdot \text{d}}$ :

$$\frac{6.5}{0.18} = 36 \text{ times the carbon dioxide uptake of the pond itself.}$$

## Appendix C: Carbon Dioxide Stripping from Diesel Exhaust Gases

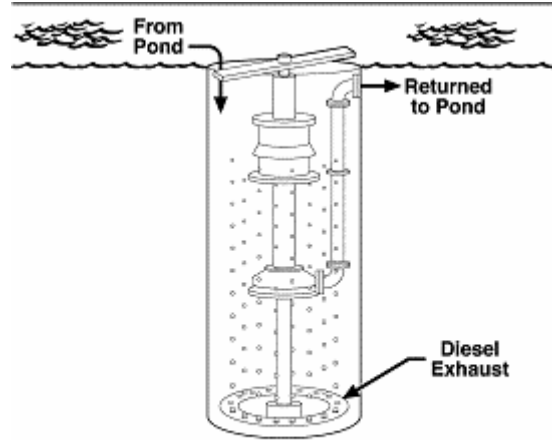

### Overview:

Owing to the very small (1%) contribution of atmospheric carbon dioxide to the carbon needs of the high rate algae growth pond, a digester would be used to produce methane and carbon dioxide from volatile solids in animal litter. The methane would be used to provide electrical power and thermal energy to the farm via a diesel generator, and the carbon dioxide from the digester and the diesel engine would be scrubbed with pond water to absorb as much of the carbon dioxide as would be economically feasible. We believe that a simple bubble column, a pit with downward pond water flow and upward carbon-dioxide containing gas flow, would be appropriate for this scrubbing operation. This appendix contains design information for the bubble column. Note that the system is sized for 12 hours per day operation, a seasonal average for the duration of the photosynthesis period.

### Basis:

40 kg carbon required per day for the 1 acre growth pond (algae assumed to be 50 wt% carbon), diesel exhaust is 20 mole % carbon dioxide

### Carbon Dioxide Concentration:

$$PV = \frac{w}{M}RT,$$

$$\frac{w}{M} = \frac{(1 \text{ atm})(20\%) \left(44 \frac{\text{g}}{\text{mol}} \text{CO}_2\right)}{\left(0.082 \frac{\text{L} \cdot \text{atm}}{\text{mol} \cdot \text{K}}\right)(300 \text{ K})} = 0.35 \frac{\text{kg CO}_2}{\text{m}^3 \text{ Exhaust}}$$

### Gas Flow Rate:



$$\left(\frac{40 \text{ kg C}}{\frac{1}{2} \text{ d}}\right) \left(\frac{44 \text{ kg CO}_2}{12 \text{ kg C}}\right) \left(\frac{1 \text{ m}^3}{0.35 \text{ kg}}\right) \left(\frac{1 \text{ d}}{1440 \text{ min}}\right) \left(\frac{1 \text{ min}}{60 \text{ s}}\right) = 0.0096 \frac{\text{m}^3}{\text{s}}$$

$$\text{or } \left(0.0096 \frac{\text{m}^3}{\text{s}}\right) \left(\frac{60 \text{ s}}{1 \text{ min}}\right) \left(\frac{35 \text{ ft}^3}{1 \text{ m}^3}\right) = 20 \text{ cfm}$$

Minimum Cross-sectional Area of Column Required:

For 10% gas volume fraction in column (to ensure the good mass transport rates of bubbly flow (Shah 1982)), and for a bubble rise velocity of 0.3 m/s:

$$A = \frac{\left(0.0096 \frac{\text{m}^3}{\text{s}}\right)}{\left(0.3 \frac{\text{m}}{\text{s}}\right) (10 \%)} = 0.32 \text{ m}^2 \text{ (diameter of 64 cm or 2.1 ft)}$$

Note : This will be increased below for other reasons.

Height of Column Required:

By sizing the column so that only 10% of the volume is gas, we can assume that the gas bubbles, estimated to be 3 mm in diameter (0.003 m), rise individually at their terminal velocity of 0.3 m/s. We can follow the mass transport of an individual bubble as it rises through the water column, to calculate the number of seconds, and thus the column height, required for the bubble to lose 90% of its carbon dioxide. We chose 90% recovery because the concentration of carbon dioxide in the bubble will decline exponentially with time, so that it would take the same additional column height to go from 10% (absolute) carbon dioxide remaining to 1% (absolute) carbon dioxide remaining as it would for the 100% to 10% reduction, which may not be economically attractive.

Assuming that the liquid flow rate is ten times the stoichiometric amount required (the carbon dioxide is only 10% of its saturation value at the liquid phase exit) we can approximate the bulk liquid carbon dioxide concentration as 0.

Liquid-side Mass Transport:

The transport rate of carbon dioxide from the bubble surface is

$$k_L(C - 0)A, \text{ where}$$

$$k_L = \text{liquid phase mass transport coefficient, taken as } 0.00016 \frac{\text{m}}{\text{s}} \text{ (Shah 1982),}$$

$$A = \text{bubble surface area, m}^2,$$

$$\text{and } C = \text{liquid phase carbon dioxide concentration, } \frac{\text{mol}}{\text{m}^3}.$$

From Henry's Law at 30 °C:

$$C = P_A \left( \frac{56,000 \text{ mol}}{1 \text{ m}^3} \right) \left[ \frac{\text{mole fraction}}{2000 \text{ atm}} \right], \text{ where}$$

$P_A$  = partial pressure of carbon dioxide, atm,

$56,000 \frac{\text{mol}}{\text{m}^3}$  = molar density of water,

2000 = Henry's Law constant for carbon dioxide at 30 °C,  $\frac{\text{atm}}{\text{mole fraction}}$  (from

*Perry's Chemical Engineers' Handbook*),

and  $C = 28P_A$ .

Gas Bubble Content:

The rate of carbon dioxide transfer out of the bubble and into the liquid phase in terms of the time rate of change of carbon dioxide partial pressure in the gas bubble is

$$V \left( 41 \frac{\text{mol}}{\text{m}^3 \cdot \text{atm}} \right) \frac{dP_A}{dt}, \text{ where}$$

$V$  = gas bubble volume,  $\text{m}^3$ ,

$41 \frac{\text{mol}}{\text{m}^3 \cdot \text{atm}}$  = molar volume of ideal gas at 30 °C,

and  $\frac{dP_A}{dt}$  = time rate of change of carbon dioxide partial pressure in bubble,  $\frac{\text{atm}}{\text{s}}$ .

Equating the Transport and Time Rate-of-change Terms:

$$41V \frac{dP_A}{dt} = \left( 0.00016 \frac{\text{m}}{\text{s}} \right) 28 \cdot A \cdot P_A$$

Rearranging:

$$\frac{dP_A}{P_A} = \left( \frac{0.00016 \cdot 28}{41} \right) \left( \frac{A dt}{V} \right)$$

For a 0.003 m bubble,  $\frac{A}{V} = 2000 \text{ m}^{-1}$ , and

$$\frac{dP_A}{P_A} = \frac{(0.00016)(2000)(28)}{41} dt = 0.22 dt.$$

Integration gives

$$\ln\left(\frac{P_{A1}}{P_{A2}}\right) = 0.22t.$$

For a 10-fold reduction in partial pressure of carbon dioxide,

$$t = \frac{\ln(10)}{0.22} = 10 \text{ seconds.}$$

Since the bubble rise velocity is 0.3 meters per second, the minimum column height,  $H$ , would be

$$H = \left(0.3 \frac{\text{m}}{\text{s}}\right)(10 \text{ s}) = 3 \text{ m.}$$

#### Liquid Flow

We choose a liquid flow rate which is 10 times the stoichiometric amount, so that the exiting carbon dioxide concentration is low enough to ensure near-maximum mass transport from the bubbles to the liquid phase.

Carbon Dioxide Entering with Gas Phase:

$$\left(0.0096 \frac{\text{m}^3}{\text{s}}\right) \left(0.35 \frac{\text{kg CO}_2}{\text{m}^3}\right) \left(\frac{1 \text{ mol CO}_2}{44 \text{ g CO}_2}\right) = 0.076 \frac{\text{mol CO}_2}{\text{s}}$$

Saturation Concentration of Carbon Dioxide in Pond Water:

$$C = 0.2 \text{ atm} \left(\frac{56,000 \text{ mol Water}}{1 \text{ m}^3}\right) \left[\frac{\text{mole fraction}}{2000 \text{ atm}}\right] = 5.6 \frac{\text{mol CO}_2}{\text{m}^3}$$

Liquid Flowrate at 10 times stoichiometric:

$$L = \frac{\left(0.076 \frac{\text{mol CO}_2}{\text{s}}\right)}{\left(5.6 \frac{\text{mol CO}_2}{\text{m}^3}\right)} \times 10 = 0.136 \frac{\text{m}^3}{\text{s}} = 2000 \text{ gpm}$$

Liquid Velocity in Column:

$$v = \frac{0.136 \frac{\text{m}^3}{\text{s}}}{0.32 \text{ m}^2} = 0.42 \frac{\text{m}}{\text{s}}$$

Note: The terminal velocity of the gas bubbles is 0.3 meters per second, which means that this liquid velocity would create gas holdup problems. We therefore need to reduce the liquid velocity in the column, perhaps by a factor of ten, to 0.042 meters per second, by increasing the column area by a factor of ten, to 3.2 m<sup>2</sup> (2 meters or 6.6 feet in diameter). This is for a 1-acre pond. It would be 32 m<sup>2</sup> (10 meters or 33 feet in diameter) for a 10-acre pond

Liquid Pumping Power:

$$P = \left(0.136 \frac{\text{m}^3}{\text{s}}\right) \left(1000 \frac{\text{kg}}{\text{m}^3}\right) (1 \text{ m}) \left(9.8 \frac{\text{m}}{\text{s}^2}\right) = 1,330 \text{ W (for 12 hours)}$$

Gas Pumping (Compression) Power ( $P_G$ ) (Anderson 2002):

$$P_G (\text{HP}) = Q_G (\text{cfm}) \left\{ 528 \left[ \left( \frac{P + 407}{407} \right)^{0.286} - 1 \right] \left( \frac{1}{0.7} \right) 0.000425 \right\}, \text{ where}$$

$$Q_G = \left(0.0096 \frac{\text{m}^3}{\text{s}}\right) \left(\frac{35 \text{ ft}^3}{1 \text{ m}^3}\right) \left(\frac{60 \text{ s}}{1 \text{ min}}\right) = 20 \text{ cfm},$$

$P = 120$  in water,

and 0.7 is the assumed efficiency of the compressor.

$$P_G = 0.5 \text{ HP} = (0.5 \text{ HP}) \left(\frac{746 \text{ W}}{1 \text{ HP}}\right) = 380 \text{ W (for 12 hours)}$$

Pit Volume:

$$V = \frac{\pi}{4} D^2 h = 0.7854 (2 \text{ m})^2 (4 \text{ m}) = (12.6 \text{ m}^3) \left(\frac{35 \text{ ft}^3}{1 \text{ m}^3}\right) \left(\frac{7.5 \text{ gal}}{1 \text{ ft}^3}\right) = 3,300 \text{ gal}$$

## Appendix D: Pond Mass Balance

Basis: 1 acre pond,  $\sim 4000 \text{ m}^2$

Production Rate ( $P$ ):

$$P = \left( 20 \frac{\text{g Algae}}{\text{m}^2 \cdot \text{d}} \right) \left( \frac{1 \text{ kg}}{1000 \text{ g}} \right) (4000 \text{ m}^2) = 80 \frac{\text{kg Algae}}{\text{d}}$$

Harvesting Flow Rate ( $Q_H$ ) at an Algae Concentration of 200 ppm:

$$\begin{aligned} Q_H &= \left( 80 \frac{\text{kg Algae}}{\text{d}} \right) \left( \frac{10^6 \text{ kg Pond Water}}{200 \text{ kg Algae}} \right) \left( \frac{1 \text{ m}^3}{1000 \text{ kg}} \right) = 400 \frac{\text{m}^3 \text{ Pond Water}}{\text{d}} \\ &\left( 400 \frac{\text{m}^3}{\text{d}} \right) \left( \frac{1000 \text{ L}}{\text{m}^3} \right) \left( \frac{1 \text{ gal}}{4 \text{ L}} \right) \left( \frac{1 \text{ d}}{1440 \text{ min}} \right) = 70 \text{ gpm} \end{aligned}$$

Pond Water Residence Time ( $\tau$ ):

$$\text{Pond Volume: } A \cdot h = 4000 \text{ m}^2 \cdot 0.2 \text{ m} = 800 \text{ m}^3$$

$$\text{Residence Time: } \tau = \frac{800 \text{ m}^3}{400 \frac{\text{m}^3}{\text{d}}} = 2 \text{ d}$$

Makeup Water Requirement:

According to Borowitzka (Borowitzka 2005), typical pond evaporation rates are 3 centimeters per day. Our experience with the experimental ponds is that it is significantly less in Alabama, perhaps owing to our regularly high relative humidity, and we estimate the evaporation rate here to be, for a growing season average, of 1 centimeter per day.

For a one acre pond, the makeup flow rate ( $Q_M$ ) would be:

$$\begin{aligned} Q_M &= \left( 0.01 \frac{\text{m}}{\text{d}} \right) (4000 \text{ m}^2) = 40 \frac{\text{m}^3}{\text{d}}, \\ Q_M &= \left( 40 \frac{\text{m}^3}{\text{d}} \right) \left( \frac{250 \text{ gal}}{1 \text{ m}^3} \right) = 10,000 \frac{\text{gal}}{\text{d}}, \\ \text{and } Q_M &= \left( 10^4 \frac{\text{gal}}{\text{d}} \right) \left( \frac{1 \text{ d}}{1440 \text{ min}} \right) = 7 \text{ gpm}. \end{aligned}$$

## Appendix E: Paddlewheel Power

1 Acre Pond Dimensions:

For a 2:1 Length:Width aspect ratio of a racetrack pond with a surface area of 1 acre,

pond length ( $L_p$ ) is 90 meters,  
pond width ( $W_p$ ) is 45 meters,  
depth ( $D$ ) is 0.2 meters,  
and flow channel width ( $W_c$ ) is 22 meters.

Mean Distance of Travel from Paddlewheel, around Pond, back to Paddlewheel:

$$l = [2(90 - 20) + 2(40 - 20)]\text{m} = 180 \text{ m}$$

The hydraulic diameter ( $D_H$ ) is

$$D_H = \frac{4A_{CS}}{U}, \text{ where}$$

$U$  is the wetted perimeter, m,

$A_{CS}$  is the cross-sectional area of the channel,  $\text{m}^2$ ,

$$\text{and } D_H = \frac{4A_{CS}}{U} = \frac{4W_c D}{W_c + 2D} = \frac{4(22 \text{ m})(0.2 \text{ m})}{22 \text{ m} + 2(0.2 \text{ m})} = 0.78 \text{ m}.$$

The average velocity ( $v$ ) is 0.5 feet per second (0.15 meters per second).

Density ( $\rho$ ): 1000 kg per cubic meter

Viscosity ( $\mu$ ): 0.001 kg per meter per second

Reynolds Number:

$$\text{Re} = \frac{\rho v D_H}{\mu} = \frac{\left(1000 \frac{\text{kg}}{\text{m}^3}\right) \left(0.15 \frac{\text{m}}{\text{s}}\right) (0.78 \text{ m})}{0.001 \frac{\text{kg}}{\text{m} \cdot \text{s}}} = 117,000 \therefore \text{Turbulent Flow}$$

Paddlewheel Power (Green 1995):

$$P = Q\rho gH, \quad g = 9.8 \frac{\text{m}}{\text{s}^2}$$

$$Q = vA_{CS} = vW_c D = \left(0.15 \frac{\text{m}}{\text{s}}\right) (22 \text{ m}) (0.2 \text{ m}) = 0.66 \frac{\text{m}^3}{\text{s}}$$

Head:

$$H = \frac{v^2 n^2 (2l)}{Rh^{0.75}} + \frac{2Kv^2}{2g}, \text{ where}$$

$$n = 0.008,$$

$$l = 180 \text{ m},$$

$$Rh = .195 \text{ m},$$

$$K = 2.4,$$

$$\text{and } H = \frac{\left(0.15 \frac{\text{m}}{\text{s}}\right)^2 (0.008)^2 (2 \cdot 180 \text{ m})}{(0.195 \text{ m})^{0.75}} + \frac{2(2.4) \left(0.15 \frac{\text{m}}{\text{s}}\right)^2}{2 \left(9.8 \frac{\text{m}}{\text{s}^2}\right)} = 0.0023 \text{ m}.$$

$$P = \left(0.66 \frac{\text{m}^3}{\text{s}}\right) \left(1000 \frac{\text{kg}}{\text{m}^3}\right) \left(9.8 \frac{\text{m}}{\text{s}^2}\right) (0.0023 \text{ m}) = 15 \text{ W}$$

The total power,  $P_T$ , is the pumping power divided by the overall efficiency of the paddlewheel, the drive, and the motor. A reasonable choice for this efficiency is 10%.

$$P_T = \frac{15 \text{ W}}{0.1} = 150 \text{ W}$$

## Appendix F: Digester for Animal Litter

Overview:

The analysis below is for the digester to provide the nutrients for a one acre pond. The results would be multiplied by the number of acres of algae growth ponds for the final sizing of the digester, compressor, scrubber, and engine/generator.

Digester Sizing:

Basis: 1 acre pond

- 80 kg algae per day requires 40 kg carbon per day (50% carbon in algae).
- 40 kg carbon per day requires 133 kg poultry litter (30% volatile carbon in litter).
- Vinyard Technologies Digesters (Vinyard 2007): 3 gallons of water per pound of waste
- 10 day residence time in digester

Water Requirement per kg Waste:

$$\left(3 \frac{\text{gal Water}}{\text{lb Waste}}\right) \left(\frac{8 \text{ lb Water}}{1 \text{ gal Water}}\right) = 25 \frac{\text{lb Water}}{\text{lb Waste}} = 25 \frac{\text{kg Water}}{\text{kg Waste}}$$

Water Requirement for Digester per Day:

$$\begin{aligned} \left(133 \frac{\text{kg Litter}}{\text{d}}\right) \left(25 \frac{\text{kg Water}}{\text{kg Waste}}\right) &= 3325 \frac{\text{kg Water}}{\text{d}} \\ \left(3325 \frac{\text{kg Water}}{\text{d}}\right) \left(\frac{1 \text{ gal Water}}{4 \text{ kg Water}}\right) &= 830 \frac{\text{gal Water}}{\text{d}} \end{aligned}$$

Digester Sizing for 1 Acre Pond with a 10 Day Residence Time:

$$V = \left(830 \frac{\text{gal}}{\text{d}}\right) (10 \text{ d}) = 8300 \text{ gal}$$

Methane Output:

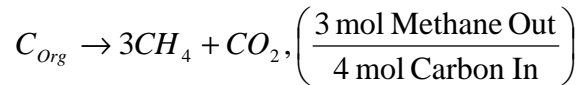

Methane Production:

$$\left(40 \frac{\text{kg C}}{\text{d}}\right) \left(\frac{1 \text{ kmol C}}{12 \text{ kg C}}\right) \left(\frac{3 \text{ kmol CH}_4}{4 \text{ kmol C}}\right) = 2.5 \frac{\text{kmol CH}_4}{\text{d}}$$



Maximum Power Produced from Methane Combustion:

$$\left(2.5 \frac{\text{kmol CH}_4}{\text{d}}\right) \left(247 \frac{\text{kW} \cdot \text{h}}{\text{kmol CH}_4}\right) \left(\frac{1 \text{ d}}{24 \text{ h}}\right) = 26 \text{ kW (per acre)}$$

Appendix I discusses the uses for this methane.

Methane (and Carbon Dioxide) Compressor Sizing:

Total Gas Flow:

$$2.5 \text{ kmol CH}_4 + \frac{2.5}{3} \text{ kmol CO}_2 = 3.3 \text{ kmol Gas}$$

Molar Volume of Gas:

$$\frac{V}{n} \left(\frac{\text{L}}{\text{mol}}\right) = \left(0.8206 \frac{\text{L} \cdot \text{atm}}{\text{mol} \cdot \text{K}}\right) \left(\frac{300 \text{ K}}{1 \text{ atm}}\right) = 25 \frac{\text{L}}{\text{mol}}$$

Gas Flow Rate:

$$Q = \left(3300 \frac{\text{mol}}{\text{d}}\right) \left(25 \frac{\text{L}}{\text{mol}}\right) \left(\frac{1 \text{ ft}^3}{29 \text{ L}}\right) \left(\frac{1 \text{ d}}{1440 \text{ min}}\right) = 2 \text{ cfm}$$

Liquid and Solid Output:

Vinyard reports a water output of 140 pounds per hour and a solids output of 3 pounds per hour for a digester sized for one acre:

$$\left(143 \frac{\text{lb Water}}{\text{h}}\right) \left(\frac{1 \text{ gal}}{8.3 \text{ lb}}\right) \left(\frac{1 \text{ h}}{60 \text{ min}}\right) = 0.4 \text{ gpm slurry output}$$

Nutrient Balance:

	<i>Poultry Litter Content</i>		<i>Algae Content</i>	
	Actual	Normalized to Carbon	Actual	Normalized to Carbon
Carbon	30%	100%	52%	100%
Nitrogen	4%	13%	9%	17%
Phosphorus	2%	7%	1%	2%

Discussion: If all the available carbon in litter is converted to algae, there would be a deficit of nitrogen and a surplus of phosphorus. Since the carbon conversion will be less than 100%, it's likely that the nitrogen will be sufficient or surplus as well.

Nutrient Concentrations in Digester:

The daily water throughput for the digester, 830 gallons per day for each acre of pond fed, would be used to carry nitrogen, phosphorus, and trace metal nutrients, supplied by the animal litter, to the ponds. The calculation below estimates the concentrations of the nitrogen and phosphorus compounds to see if solubility limits would be met.

Nitrogen: 13 wt% of Carbon

$$\left(40 \frac{\text{kg C}}{\text{d}}\right) \left(\frac{13 \text{ kg N}}{100 \text{ kg C}}\right) = 5 \text{ kg N}$$

Molarity of Nitrogen in Outflow:

$$\left(\frac{5 \text{ kg N}}{830 \text{ gal}}\right) \left(\frac{1000 \text{ g N}}{1 \text{ kg N}}\right) \left(\frac{1 \text{ mol N}}{14 \text{ g N}}\right) \left(\frac{1 \text{ gal}}{4 \text{ L}}\right) = 0.1 \frac{\text{mol N}}{\text{L}}$$

This is well below the solubility limits of the nitrogen compounds (e.g. ammonium nitrate) found in the digester.

Phosphorus: 7 wt% of Carbon

$$\left(40 \frac{\text{kg C}}{\text{d}}\right) \left(\frac{7 \text{ kg P}}{100 \text{ kg C}}\right) = 3 \text{ kg P}$$

Molarity of Phosphorous in Outflow:

$$\left(\frac{3 \text{ kg P}}{830 \text{ gal}}\right) \left(\frac{1000 \text{ g P}}{1 \text{ kg P}}\right) \left(\frac{1 \text{ mol P}}{31 \text{ g P}}\right) \left(\frac{1 \text{ gal}}{4 \text{ L}}\right) = 0.03 \frac{\text{mol P}}{\text{L}}$$

This is also well below the solubility limits of the phosphorus compounds (e.g. ammonium phosphate) found in the digester.

Litter Pit Volume:

$$(830 \text{ gal}) \left(\frac{1 \text{ ft}^3}{7.5 \text{ gal}}\right) \left(\frac{1 \text{ m}^3}{35 \text{ ft}^3}\right) = 3.2 \text{ m}^3$$

## Appendix G: Harvesting

### Flocculation

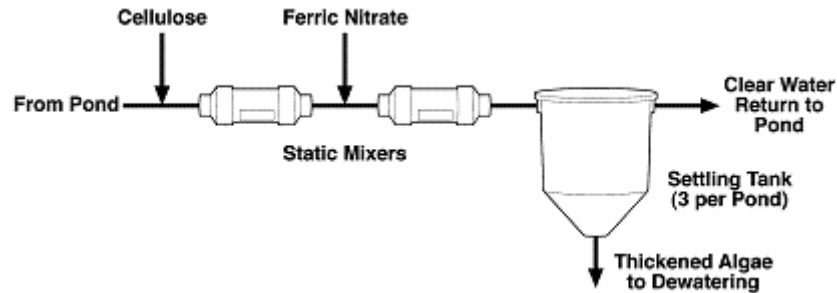

The flocculation process agglomerates individual micro-algae cells into macroscopic entities which are easily dewatered through settling, filtration, and pressing. Our two stage flocculation process starts with addition of ferric nitrate, followed by addition of cellulose fiber, and produces a fibrous floc which withstands the shear forces of dewatering.

Flocculants are typically added in stirred tanks, but we instead chose static mixers, owing to their better uniformity of mixing and lower installed and operating/maintenance costs.

The pond water flow rate to the harvesting system is 70 gpm. We selected Ross 4 inch diameter, six-element mixers for each of the two additives, which would provide the required mixing at a low pumping power, as shown below.

For 4 inch diameter elements, the pressure drop of water through each element, at 70 gpm, is 0.05 psi. The pumping power for this is as follows:

$$P \text{ (kW)} = Q \times \rho \times g \times h / 3,600,000.$$

$$Q = 70 \text{ gal/min} \times 60 \text{ min/h} \times 3.78 \text{ L/gal} \times 1 \text{ cu m} / 1,000 \text{ L} = 16 \text{ cu m} / \text{h}$$

$$\rho = 1,000 \text{ kg/cu m}$$

$$g = 9.8 \text{ m/s/s}$$

$$h = 0.05 \text{ psi/element} \times 12 \text{ elements} \times 28 \text{ inches w/psi} \times 0.0254 \text{ m/inch w} \\ = 0.43 \text{ m}$$

$$P = 19 \text{ watts.}$$

Ferric Nitrate Feed Rate:

Basis: 25 ppm pond water basis, 5% ferric nitrate solution (nine waters of hydration: molecular weight 400 g/mole)

Flowrate:

$$70 \text{ gal/min} \times 8.3 \text{ lb/gal} \times 25 \text{ lb Fe} / 1,000,000 \text{ lb pond water} \\ \times 400 \text{ lb ferric nitrate} / 56 \text{ lb Fe} \\ \times 100 \text{ lb ferric nitrate solution} / 5 \text{ lb ferric nitrate} \times 1 \text{ gal} / 8.3 \text{ lb} \\ = 0.25 \text{ gpm}$$

Daily requirement of ferric ion:

$$0.25 \text{ gal/min} \times 8.3 \text{ lb/gal} \times 5 \text{ lb ferric nitrate} / 100 \text{ lb solution} \\ \times 1,440 \text{ min/d}$$

$$= 150 \text{ lb ferric nitrate}$$
$$150 \text{ lb ferric nitrate} \times 56/400 = 21 \text{ lb ferric ion}$$

Cellulose Feed Rate:

Basis: 10% of algae weight, 5% solution

Flowrate:

$$70 \text{ gal/min} \times 8.3 \text{ lb/gal} \times 200 \text{ lb algae/1,000,000 lb water} \times 1 \text{ lb cellulose/lb algae}$$
$$100 \text{ lb solution/5 lb cellulose} \times 1 \text{ gal/8.3 lb} = 0.028 \text{ gpm}$$

Daily requirement of cellulose: 81 kg algae x 10% = 8 kg cellulose

Wet Algae Pump: @ 1% solids

$$81 \text{ kg/d} / 1\% \times 1 \text{ d/24 h} \times 2.2 \text{ lb/kg} \times 1 \text{ gal/8.3 lb} = 90 \text{ gpm}$$

Settling Tank (3 per pond):

$$70 \text{ gal/min} \times 60 \text{ min} = 420 \text{ gal}$$

## Appendix H: Dewatering and Drying

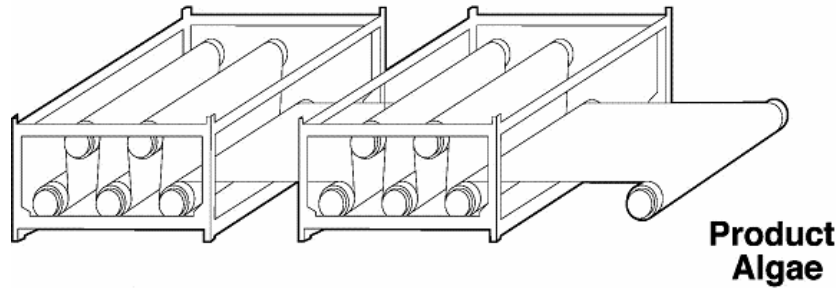

### Dewatering:

The wet, flocculated algae which are in the bottom of the settling tanks would be 1-3% solids, and would therefore require mechanical dewatering to 20% solids prior to being sent to the dryer, to minimize the amount of drying energy required. Belt filter presses are available for this; the smallest ones are rated for a minimum of 0.6 tons per hour on a dry solids basis. This throughput capability would be large enough for the production of 160 acres:

$$\left(81 \frac{\text{kg Algae}}{\text{acre} \cdot \text{d}}\right) \left(\frac{2.2 \text{ lb}}{1 \text{ kg}}\right) \left(\frac{1 \text{ d}}{24 \text{ h}}\right) \left(\frac{1 \text{ ton}}{2000 \text{ lb}}\right) = 0.0037 \frac{\text{tons Algae}}{\text{acre} \cdot \text{h}},$$

$$\frac{\left(0.6 \frac{\text{tons}}{\text{h}}\right)}{\left(0.0037 \frac{\text{tons}}{\text{acre} \cdot \text{h}}\right)} = 160 \text{ acres}.$$

One 0.6 tons per hour belt filter press would therefore service the entire farm. Each pond's harvesting system would pump the wet algae through a main line to the belt filter press for dewatering. The clear water would then be returned to the ponds.

### Water Return Flow Rate

Basis: 1% solids to 20% solids, 1 acre pond

$$\left(81 \frac{\text{kg Algae}}{\text{acre} \cdot \text{d}}\right) \left[ \left(\frac{99 \text{ kg Water}}{1 \text{ kg Algae}}\right)_{IN} - \left(\frac{80 \text{ kg Water}}{20 \text{ kg Algae}}\right)_{OUT} \right] = 729 - 324 \approx 400 \frac{\text{kg Water}}{\text{acre} \cdot \text{d}}$$

$$\left(400 \frac{\text{kg Water}}{\text{acre} \cdot \text{d}}\right) \left(\frac{1 \text{ L}}{1 \text{ kg}}\right) \left(\frac{1 \text{ gal}}{4 \text{ L}}\right) \left(\frac{1 \text{ d}}{1440 \text{ min}}\right) = 0.07 \frac{\text{gpm}}{\text{acre}}$$

### Drying:

The design production rate for a 1 acre pond is 81 kg of algae per day. The algae leaving the dewatering process would have a solids content of 20%, and must be dried to at least

90% solids to prevent spoiling in shipment and storage. The amount of water to be removed daily is therefore

$$\left(81 \frac{\text{kg Algae}}{\text{acre} \cdot \text{d}}\right) \left[ \left(\frac{80 \text{ kg Water}}{20 \text{ kg Algae}}\right)_{IN} - \left(\frac{10 \text{ kg Water}}{90 \text{ kg Algae}}\right)_{OUT} \right] = 315 \frac{\text{kg Water}}{\text{acre} \cdot \text{d}} .$$

For a heat of vaporization of  $0.54 \frac{\text{kW} \cdot \text{h}}{\text{kg Water}}$ , this would require

$$\left(315 \frac{\text{kg Water}}{\text{acre} \cdot \text{d}}\right) \left(0.54 \frac{\text{kW} \cdot \text{h}}{\text{kg Water}}\right) = 170 \text{ kW} \cdot \text{h} .$$

The methane produced by the digester would provide a total of 26 kW of power, 625 kWh of energy per day, for each acre of pond. Appendix I shows that there is thermal energy well in excess of the 170 kWh per acre needed for drying, which would be done in the drum dryer.

## **Appendix I: Energy Balance**

Appendix F showed that there would be 26 kW per acre, 2,600 kW for a 100-acre farm, of methane generated by the digester. Some of that methane would be sent to a diesel engine/generator to provide electrical power for the farm, and the remainder would be available for providing heat to the drums of the drum dryer, perhaps via a simple gas-fired forced air system.

We estimate that the total electrical load for the farm would be 100 kW, 5 kW for the front-end equipment, 20 kW for the back end equipment, 30 kW for the ponds, and the remainder for the various electrical loads on the farm. We would therefore install a 100 kW engine/generator, having an estimated efficiency of 30%. This would consume 143 kW of the methane produced by the digester and discharge 43 kW of thermal power, leaving more than 2,400 kW of methane for drying the algae. Our preliminary plan for this would be a simple methane-fired forced air heating system.

Appendix H showed that 170 kWh would be required to dry the daily production of 1 acre, thereby requiring 17,000 kWh for the farm per day, which computes to 710 kW for a 24-hour drying period. The excess available thermal power would be more than 1700 kW, counting the thermal power of the diesel. This would be transferred to the pond water in the carbonation pits.